

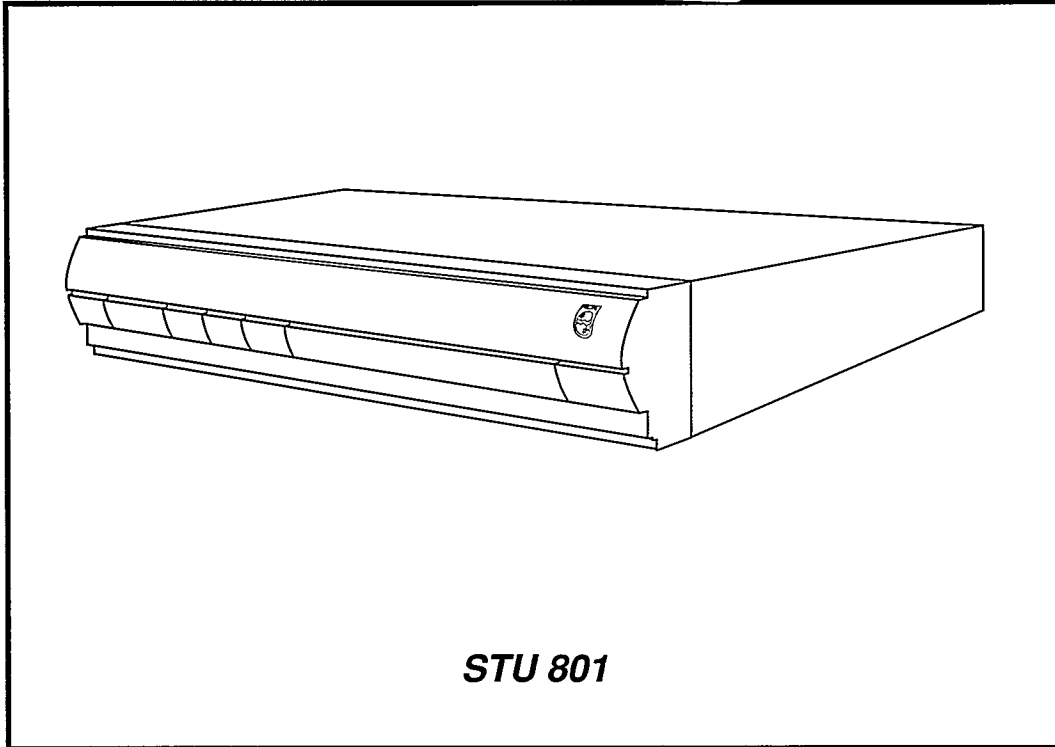

PHILIPS



SATELLITENEMPFÄNGER

RECEPTEUR SATELLITE STEREO

RICEVITORE SATELLITE

SZATELLIT FELVEVŐDET

STEREO SATELLITE RECEIVER



1. BEFORE YOU START	2
Safety Instructions	2
Mains Connection	2
About This Manual	2
2. HOW TO CONNECT YOUR RECEIVER	3
Position your Philips STU 801 Satellite Receiver	3
Insert batteries in the remote control	3
Connecting your satellite dish antenna	3
Connecting your Receiver	3
To a TV only, using a coaxial cable	4
To a TV only, using a Euroconnector	5
To a TV and a VCR, using Euroconnectors	6
To a TV and a VCR, using coaxial cables	7
Connect the Polariser	8
Aim your dish	8
Additional connections	8
AUDIO L/R	8
DECODER/DESCRAMBLER	8
3. HOW TO WATCH SATELLITE TV	9
Switch On	9
Switch Off	9
Select a Programme	9
Control Your Philips TV Remotely	9
Permanent Programme Ident Display	9
Audio Mute	9
Audio Mode	9
Programme Status	10
The TV/SAT Button	10
Change The Sound Volume	10
Auxiliary Programme	10
On-Screen Display Menus	10
Timer functions	10
Setting the Clock	10
Setting the Timer	11
Cancel an Event	11
Instant Timer/Sleep Timer	12
To operate the Instant Timer/Sleep Timer	12
The Parental Lock	12
Personalising the PIN	12
Lock a Programme	13
Unlock a Programme	13
Receiver Lock	13
VCR record/replay using Euroconnectors	13
4. PERSONALISING YOUR RECEIVER	14
Installation Menu	14
Modifying Existing Programmes (Menu 1)	15
Voltage Switching	15
The Electro-Magnetic Polariser	15
The Mechanical Polariser	16
Adding New Programmes (frequency scan)	17
5. SPECIFICATION	18
6. FAULT FINDING	20
7. PROGRAMME GUIDE	21
PROGRAMME GUIDE (Cont.)	22

Safety Instructions

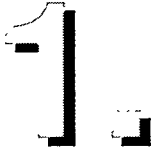

To avoid short-circuits, which may cause fire or electric shock, do not expose this Philips STU 801 Satellite Receiver to rain or moisture.

Dangerous voltage inside. Do not open the cabinet.

There are no user serviceable parts inside.

Repairs should be carried out by qualified service personnel only.

NEVER connect or modify cables while the Receiver is connected to the mains. Always first remove the plug from the wall socket.

Ensure that no objects or fluids pass through the ventilation openings.

If liquid is spilt into the Receiver, disconnect the Receiver from the mains and consult a qualified service technician.

Do not put your Receiver close to an external source of heat (radiator, etc.)

Ensure that air can circulate freely through the ventilation openings of the Receiver.

Avoid using the Receiver on soft surfaces or near appliances generating strong magnetic fields (eg motors, transformers).

Do not use your Receiver in dusty places or where it may be subject to vibration.

Avoid using your Receiver immediately after moving from a cold to a warm location and vice versa, or under conditions of high humidity.

If you have to transport your Receiver, avoid violent shocks.

Your Receiver supplies 14 or 18 V DC voltage to your satellite dish antenna.

Make sure you only connect your satellite dish to the satellite dish inputs and nothing else.

For cleaning, use a damp chamois leather - never use an abrasive.

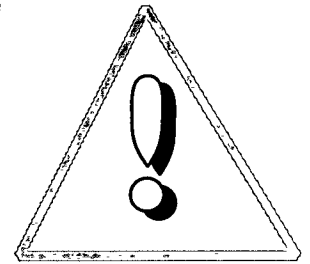

Mains Connection

Before connecting the Receiver to the mains, check that the mains supply voltage corresponds to the voltage printed on the rear panel of your Receiver. If the mains voltage is different, consult your dealer.

NEVER connect or modify cables while the Receiver is connected to the mains. Ensure that the mains plug is not plugged in to the mains supply before proceeding further.

About This Manual

This is a manual to help you with the installation and operation of your new Satellite Receiver.

- This circle in front of a sentence indicates that you have to **do** something.
- ▷ This arrow in front of a sentence indicates the **result** of what you have done.

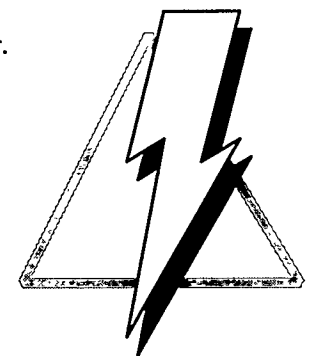

HOW TO CONNECT YOUR RECEIVER

Position your Philips STU 801 Satellite Receiver

2

The STU 801 is intended for use in a domestic environment only and should never be operated or stored in an excessively hot or humid atmosphere.

Choose a position at some distance away from radiators or other sources of heat.

Leave a clear space of at least 3 cm all around the Receiver for ventilation.

Make sure that curtains, cupboards, etc. cannot obstruct air flow through the ventilation openings.

CONNECTIONS

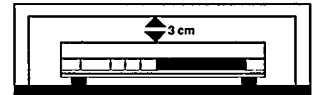

Insert batteries in the remote control

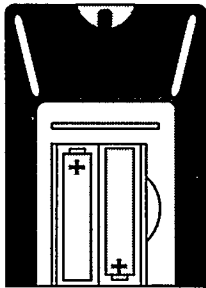

- Remove the battery cover located on the back of the remote control handset.
- Insert two batteries (type LR03 1.5 V).
- Replace the battery cover.

Connecting your satellite dish antenna

First, install the dish antenna and its receiving element - the Low Noise Converter (LNC) - according to the manufacturer's instructions.

Make sure your Satellite Receiver is not connected to the mains while connecting the dish antenna to your Receiver.

Connect the satellite antenna cable to the connector marked 1 on the back of the Receiver, using the connector supplied with your Receiver.

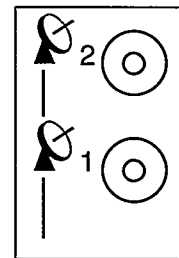

Connecting your Receiver

This section tells you how to connect the Philips STU 801 Satellite Receiver to the equipment you already have, such as a TV and Video Cassette Recorder (VCR).

There are many connection options of which the most common are:

- a. To a TV only, using a coaxial cable.
- b. To a TV only, using a Euroconnector.
- c. To a TV and a VCR, using Euroconnectors.
- d. To a TV and a VCR using coaxial cables.

Option B is the best if you have a TV only because it gives the best picture and sound quality. You will obtain even better sound if you connect the Receiver to your hi-fi system. See **Additional Connections** section of this manual.

Select one of the connection options, then follow the step-by-step instructions on that page.

GB

CONNECTIONS

To a TV only, using a coaxial cable

a.

1. Make the connections as shown in the drawing using the coaxial cable supplied with your Receiver.
2. Connect your Receiver to the mains socket.
3. Switch your TV ON.
4. Switch the test picture switch on the back of your Receiver to TEST.
5. Switch your TV to each of its programme numbers in turn to check that your Receiver is not causing interference with terrestrial programmes.
6. If there is patterning, or any other interference on the screen, adjust the TUNE control on the back of the Receiver until you have a clear picture. Only a small adjustment, sufficient to remove the patterning, should be made at a time.
7. Continue this procedure until you have checked all the programme numbers on your TV.
8. Select a spare programme number on your TV which you will always use for satellite programmes - this is now your 'Satellite Receiver number'. Tune your TV until you find a picture from the Receiver. You will know that you are looking at a picture from the Receiver when you see this picture appear on your TV screen.
9. If the reception is poor, use a small screwdriver to turn the tune control on the Receiver until the reception is clear. Go back to Step 5.
10. Switch the test picture switch on the back of the Receiver back to NORM.
11. Go to the section **Connect Your Polariser** or **Aim your dish**.

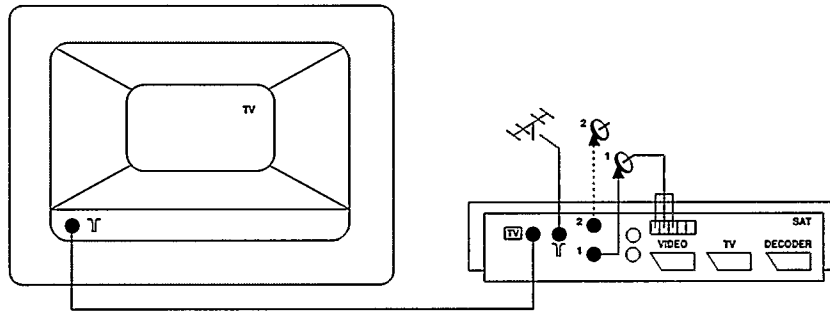
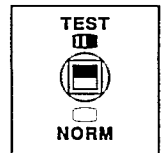
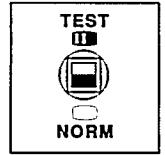

To a TV only, using a Euroconnector

b.

1. Make the connections as shown in the drawing.
2. Connect your Receiver to the mains socket.
3. Switch your TV ON.
4. Press button number 1 on your Receiver remote control.
5. Press MENU followed quickly by 1 on your remote control. The ● light on your Receiver should now be blinking. Also your TV should now show the Satellite Receiver picture or, at least, text on the screen. If not, you may have to select the AV input on your TV.
6. Press VIEW on your remote control.
7. Go to the section **Connect Your Polariser or Aim your dish.**

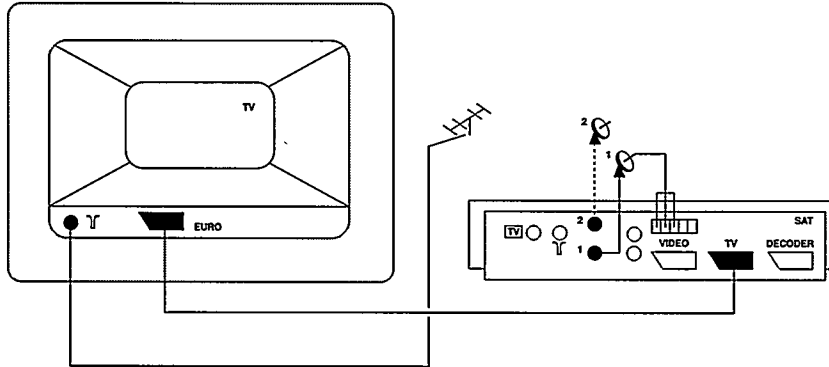

GB

CONNECTIONS

C.

To a TV and a VCR, using Euroconnectors

1. Make the connections as shown in the drawing.
2. Connect your Receiver to the mains socket.
3. Switch your TV **ON**.
4. Press button number 1 on your Receiver remote control.
5. Press MENU followed quickly by 1 on your remote control. The ● light on your Receiver should now be blinking. Also your TV should now show the Satellite Receiver picture or, at least, text on the screen. If not, you may have to select the A/V input on your TV.
6. Switch the Receiver to standby using the ⏻ key on the remote control. Play a video cassette in your VCR. If you do not see a picture from the VCR, check the connections as below.
7. Switch your VCR off.
8. Press VIEW on your remote control.
9. Go to the section **Connect Your Polariser** or **Aim your dish**.

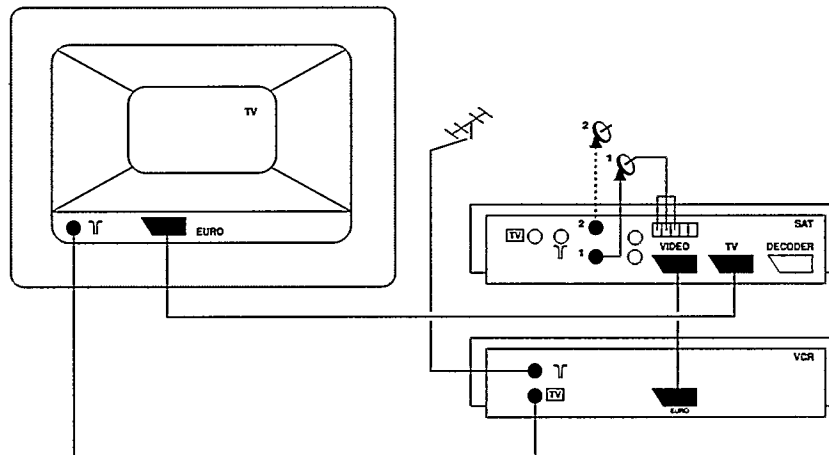

To a TV and a VCR, using coaxial cables

CONNECTIONS

d.

1. Make the connections as shown in the drawing using the cable supplied with your receiver.
2. Connect your Receiver to the mains socket.
3. Switch your TV ON.
4. Switch your VCR ON.
5. Switch the test picture switch on the back of the Receiver to TEST.
6. Switch your TV to each of its programme numbers in turn to check that your Receiver is not causing interference with terrestrial programmes.
7. If there is patterning, or any other interference on the screen, adjust the TUNE control on the back of the Receiver until you have a clear picture. Only a small adjustment, sufficient to remove the patterning, should be made at a time.
8. Continue this procedure until you have checked all the programme numbers on your TV.
9. Select a spare programme number on your TV which you will always use for satellite programmes - this is now your 'Satellite Receiver number'. Tune your TV until you find this picture from the Receiver.
10. If the reception is poor, use a small screwdriver to turn the TUNE control on the Receiver until the reception is clear. Go back to Step 6.
11. On your TV, select the programme number you use to watch your VCR.
12. Select a spare programme number on your VCR which you will always use for satellite programmes. It is a good idea to use the same programme number as your TV 'Satellite Receiver number'.
13. Tune your VCR until you find the picture from the Receiver.
14. If there is patterning, or any other interference on the screen, adjust the tune control on the back of the Receiver until you have a clear picture. Only a small adjustment, sufficient to remove the patterning, should be made at a time.
Now check all the VCR programmes for possible patterning. Select your Satellite Receiver number on your TV and check again the TV programmes for possible patterning. If a problem occurs, go back to Step 7.
15. Switch the test picture switch on the back of the Receiver to NORM.

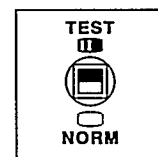
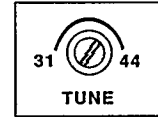
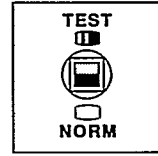

GB

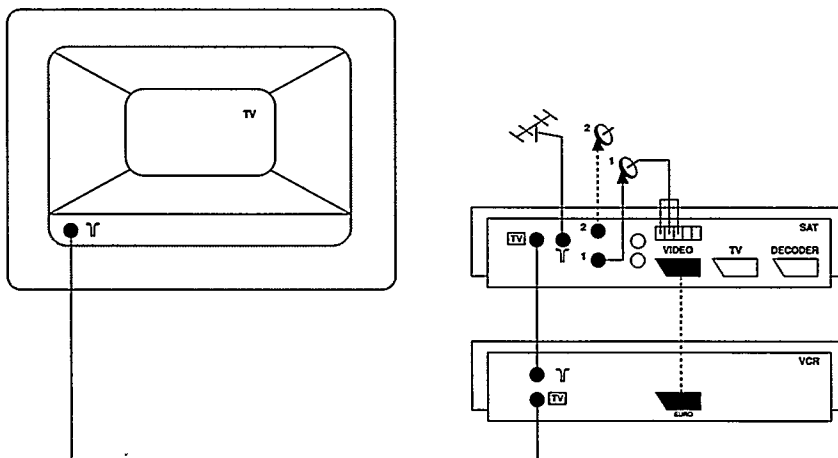

Connect the Polariser

Signals from a satellite are transmitted with different polarisations. There are 4 kinds of polarisation:

Direct Broadcast Satellites DBS (TV satellites like TDF, TV SAT and TELE-X) transmit with circular polarisation:

Left hand circular = L, or Right hand circular = R.

All other satellites (such as ASTRA) transmit with linear polarisation:

Horizontal = H, or Vertical = V.

For proper reception, you may need a device called a Polariser which is located in the LNC assembly of your dish antenna. This depends on what type of dish antenna you have.

If you have a **Mechanical Polariser**, connect the 3 small leads from your antenna cable to the Polariser connectors on the back of your Satellite Receiver:

- the dark lead to GND (coloured Green)
- the red lead to +5V_{DC} (coloured Red)
- the white lead to \square (pulse - coloured White)

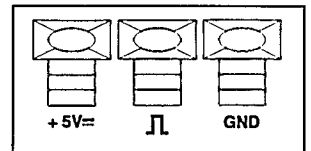

If you have an **Electro-magnetic Polariser**, connect the 2 small leads from your antenna cable to the polariser connectors on the back of your Receiver:

- the dark lead to the right hand Yellow connector
- the red lead to the left hand Yellow connector

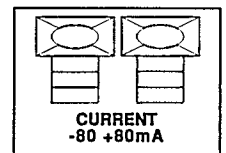

Aim your dish

Consult the Satellite Programme Guide in the back of this manual and choose a programme number on the satellite at which you will aim your dish. Now finalise installing your dish following the instructions supplied with the dish. If you cannot obtain a satisfactory picture, see section 6 'FAULT FINDING'.

Additional connections

AUDIO L/R

If you wish to use your hi-fi installation to listen to satellite programmes then you must connect it to the audio sockets.

Connect the output sockets AUDIO L (left channel) and AUDIO R (right channel) to a pair of left and right input sockets on your hi-fi installation.

Do not connect AUDIO L/R to the sockets marked PHONO of your hi-fi installation.

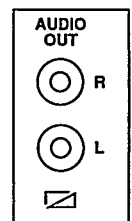

DECODER/DESCRAMBLER

Your Receiver has the capability of accepting up to two external decoders via the DECODER/DESCRAMBLER connector.

This DECODER/DESCRAMBLER connector may also be used to connect another peripheral or (MAC) satellite Receiver. In this case, select programme 0 (AUX) to watch this peripheral.

Consult your dealer for a suitable lead.

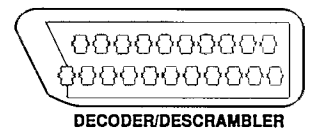

3

HOW TO WATCH SATELLITE TV

The following information assumes that your satellite dish and Receiver have been correctly installed. If this is not the case, refer to chapter 4 PERSONALISING YOUR RECEIVER, (page14).

Operation is carried out by use of the remote control. When selecting the on-screen graphics menus, it will be necessary to use 2 keys which must be pressed within a timeout period (usually 2 seconds between each key press). This is also true for other multi-key functions.

Switch On

After making all the necessary connections (see section 'HOW TO CONNECT YOUR RECEIVER'), connect the Receiver, TV and/or VCR to the mains supply and switch on. Select your 'Satellite Receiver number' on your TV or select the A/V input on your TV if you use Euroconnectors. When the mains supply is first connected, the Receiver will be in standby. To bring the Receiver out of standby, press the ◀ or ▶ key or select a programme number, using the remote control. You may also use the + or - buttons on the front of the Receiver.

OPERATION

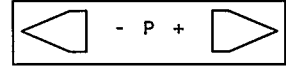

Switch Off

To 'power down' the Receiver, press the ⏻ key on the remote control or the Receiver. The Receiver will stay in standby mode as long as the mains supply is connected.

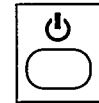

Note: Your Receiver may have been installed by looping the TV aerial through the Receiver. If this is the case, the Receiver must always be connected to the mains supply in order to watch terrestrial TV programmes.

Select a Programme

There are 2 modes of operation, single digit mode and double digit mode. Pressing the +/- key "toggles" between these two modes. In single digit mode only programmes 0-9 can be directly entered. In double digit mode, all programmes can be accessed directly by entering the appropriate 2 digits. In this mode programmes 0-9 must be preceded by a 0. It is also possible to browse through all the programmes using the ◀ or ▶ keys. The programme ident will be displayed briefly in the top right-hand corner of the TV screen.

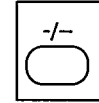

Control Your Philips TV Remotely

At the top left side of your Receiver Remote Control unit is a hidden switch. If you press this in, and continue to hold it down, your Receiver Remote Control can act as a TV Remote Control for Philips TV's. You can then change TV programmes by pressing the programme numbers on the Receiver Remote Control. This function may not work with some older Philips TV sets.

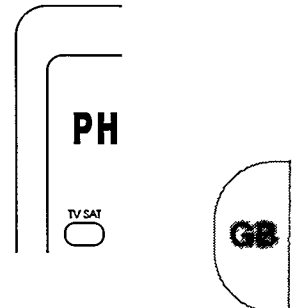

Permanent Programme Ident Display

It is possible to permanently display the programme ident on your TV screen. This feature is selected by pressing the MENU key followed by the 8 key. Repeat MENU, 8 to remove the feature.

Audio Mute

- To mute the sound press the 🔇 key.
- ▶ The MUTE symbol will appear.
- Press 🔇 again to restore the sound.

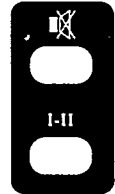

Audio Mode

The I-II key is used to cycle through all the audio modes. On certain programmes it is possible to receive multi-language, stereo or radio transmissions, e.g. Sky One also transmits Sky Radio in addition to the Sky One soundtrack. To hear these alternative transmissions, press the I-II key to select the desired mode.

Programme Status

Pressing the  key will display the programme ident, audio mode and audio frequency of the programme you are viewing and also the receivers clock (flashing if not set).

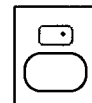

The TV/SAT Button

With some TV sets, it may be impossible to select a terrestrial TV programme while the Receiver is switched on. This may happen when you have your Receiver connected to your TV by means of an A/V connector cable.

If this occurs, you should press the TV/SAT button on your Remote Control **once**. Now you can select and watch terrestrial TV programmes.

To return to satellite programmes, press the TV/SAT button **once** again.

If you have no problem changing TV channels while your Receiver is switched on, you will not need to use the TV/SAT button.

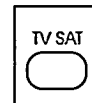

Change The Sound Volume

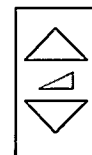

If you have a Philips TV, you may be able to control the volume of the sound with your Receiver remote control. This may not be possible with some older Philips TV sets. With most other makes of TV sets, the volume button on your Satellite Receiver Remote Control will have no effect.



Auxiliary Programme

Pressing the 0 key will select an auxiliary programme which is set up to work with an external (MAC) Receiver connected to the DECODER/DESCRAMBLER connector. It must be noted that this is in fact Programme 60 and changing the AV source setting for that programme will affect the function of the 0 key.

On-Screen Display Menus

Certain functions of the Receiver are performed by use of On-Screen Display menus (O.S.D) e.g. timer functions and modifying or adding new programmes. Once in a menu, the MENU and  keys are used to move forward and backward through the parameters and the  and  keys are used to alter parameters.

Direct entry using the numeric keys is also possible and shall be highlighted as we go through the functions. If you want to cancel alterations in a menu, press the VIEW key and this will remove the menu from your screen and erase any changes.

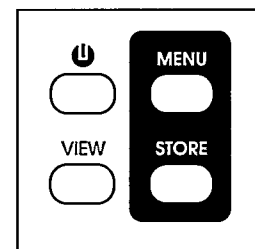







Timer functions

The Receiver has a built-in timer facility which allows it to switch on and off at selected times. The primary use of this is to record satellite events, in conjunction with a VCR, whilst the Receiver is unattended.

Note: The Receiver and VCR should have the same start and stop recording times.

Setting the Clock

- Press MENU followed by 4.
- ▷ The  light on the Receiver will be flashing.
- Press  or  to adjust the day.
- Press MENU again.
- Press  or  to adjust the hour.
- Press MENU again.
- Press  or  to adjust the minutes.
- Press STORE to store your settings.

You may also enter the hours and minutes using the numeric keys on your remote control.

Note: You need to set the clock again after the Receiver has been disconnected from the mains supply.

SO = SUNDAY
 MO = MONDAY
 DI = TUESDAY
 MI = WEDNESDAY
 DO = THURSDAY
 FR = FRIDAY
 SA = SATURDAY

Setting the Timer

The Timer menu gives you the facility to preset up to 4 events each up to 14 days in advance. It is selected by pressing the MENU key followed by the 5 key. The ● light will be flashing. Again the MENU and ⏻ keys are used to control the menu. If you have not set the Receiver's clock yet, a message CLOCK NOT SET will be displayed. In this case, follow the procedure SETTING THE CLOCK first before setting the timer.

1. EVENT

- Press ◀ or ▶ to choose an event number

2. PROGRAMME

- Select the programme you want to record using the ◀ or ▶ keys or the numeric keys on your remote control. The event is disabled when set to OFF. If a locked programme is selected, the programme ident will be preceded by an asterisk (*).

3. DAY

- Allows you to select the day of the event by using the ◀ or ▶ keys.
- ▶ The current day will be displayed as TODAY and subsequent days are prefixed 1ST or 2ND to cover the relevant week.

4. START

- Allows you to enter the start time in hours and minutes by direct entry using the numeric keys or with the ◀ or ▶ keys.

5. STOP

- Allows you to enter the stop time.
- To exit the menu press either the VIEW or STORE key.

If any recording times conflict with each other, they are detected by the timer and an EVENT OVERLAP alarm is displayed on the TV screen. This alarm may be ignored by pressing the VIEW key in which case the end of the overlapped event will be lost. The error may be corrected by re-entering the Timer menu and adjusting the start/stop times.

If a locked programme has been stored in the programme option, the message EVENT USES LOCKED PROGRAMME will appear on screen. This programme will have to be unlocked to enable the event to be recorded.

The timer is activated after the Receiver is switched to standby.

Should a Timer event occur while you are watching a satellite programme, then the ● light will flash rapidly for one minute. Press ⏻ to enable this event. If you ignore the indication, the event will be cancelled.

Note: During a timer event, all remote control commands will be ignored.

Cancel an Event

Assuming that the event has not yet started:

- Switch the Receiver on
- Press MENU followed by 5
- Select the event you want to cancel using the ◀ or ▶
- Press MENU again
- Press 0, 0
- ▶ The event is now set to OFF.

To disable the timer **during a timer event**, press the ⏻ key quickly followed by VIEW.

A message TIMER CANCELLED will be displayed.



Instant Timer/Sleep Timer

The Instant Timer enables you to record transmissions instantaneously and switch off the Receiver at a time you set.

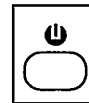

To operate the Instant Timer/Sleep Timer

- Press the **⏻** Key
- ▷ The **●** light will start to flash.
The current time will be assumed as the start time and the stop time will default to half an hour from the start time.
Use the numeric keys on the remote control to change the stop time.
- Press STORE.
- ▷ The **●** light will now stay on.
All remote control commands will now be ignored.
The Receiver will go to standby when the stop time has been reached.
- Press the **⏻** key again to **cancel** the Instant Timer/Sleep Timer.
- ▷ A message SLEEP TIMER CANCELLED will be displayed.

The Parental Lock

The parental lock feature of the Receiver allows you to 'lock out' some or all of the satellite programmes. In simple terms, you create a personal identification number (PIN) and allocate it to the programme you wish to lock to prevent unauthorised viewing. Once a programme is locked, it can only be viewed by re-entering the PIN. It is not essential to personalise the PIN, but it is recommended.

Personalising the PIN

- Press MENU followed by 7
- Enter **1234** (the default setting) using the numeric keys on your remote control.
- ▷ The Receiver will now ask for your NEW PIN.
- Enter a new PIN (4 numbers)
- ▷ The Receiver will ask you to CONFIRM PIN.
- Re-enter your new PIN.
- ▷ A message CONFIRMED will appear on the screen.

If your NEW PIN and CONFIRM PIN were not identical, a message FAILED will be displayed. It will be necessary to repeat the whole sequence.

DO NOT FORGET YOUR PIN!!!

If you forget your PIN you will have to contact your dealer.

Lock a Programme

- Press MENU followed by 6
- ▷ A message TO LOCK ENTER PIN will appear.
- Enter your PIN
- ▷ A message LOCKED will appear.

If you now select a locked programme, the message PROGRAMME LOCKED ENTER PIN will appear.

- Enter your PIN.

If the PIN is correct, the programme will be displayed.

Unlock a Programme

- Select the programme you want to unlock entering your PIN code
- Press MENU followed by 6
- ▷ A message TO UNLOCK ENTER PIN will appear
- Enter your PIN
- ▷ A message UNLOCKED will appear, indicating that this programme is now permanently unlocked.

Receiver Lock

To avoid accidental changes or unauthorised reprogramming of your Receiver, you can switch on the Receiver Lock. This disables the Installation menus (MENU 1 and MENU 2) and the frequency scan (MENU 3).

To enable the Receiver Lock, select Programme 0 (AUX) and follow the procedure to lock a programme.

To regain access, follow the procedure to unlock Programme 0 permanently.

VCR record/replay using Euroconnectors

When using a Euroconnector to connect a VCR, the following must be noted.

To record from the satellite Receiver to a VCR, it will be necessary to select AUX or AV on the VCR as the programme to record.

When replaying the VCR through the Satellite Receiver, switch the Satellite Receiver to standby.

Note: This method of replaying is only possible if the TV is also connected using a SCART lead.

Installation Menu

4.

In this menu, you will find a number of general settings for your Receiver. After you have adapted the values to those fitting your installation and connections, you normally do not have to enter this menu anymore.

- Press MENU followed by 2
- ▷ The ● light will be flashing and a menu like the one shown will appear on your screen.

If you decide not to modify anything or undo your modifications, press VIEW. The MENU and ● keys are used to move forward and backward through the menu, and the ◀ and ▶ are used to alter parameters. When you have finished your modifications, press STORE to store your settings.

The following options are available:

CONTRAST	MED
LNC1 OFFSET	15
LNC1 ASTRA BAND	
LNC2	MECH
H-POL BASE	15
V-POL BASE	50

1. CONTRAST

This is the picture contrast setting. Use the ◀ or ▶ keys to set the contrast to LOW, MEDIUM or HIGH. Pressing the STORE key will retain any adjustments made.

2. LNC 1 OFFSET

If the picture is speckly, it may be necessary to adjust the LNC offset. If you still have menu 2 on your screen, press STORE (or VIEW).

- Press MENU followed by 1 on your remote control.
- ▷ The ● light on your Receiver will now be flashing. Check that the frequency for the chosen programme is correct. (See the Satellite Programme Guide in the back of this manual). If necessary, correct the frequency using the ◀ or ▶ keys on your remote control.
- Press STORE twice.
- Press MENU followed by 2.
- Press MENU again to select LNC1 OFFSET
- Use the ◀ or ▶ key to get a picture as free from sparkles as possible.
- To optimise the picture, it is possible to change programmes whilst in this menu by directly entering the programme number using the numeric keys.
- Press STORE to store your settings. The same procedure can be followed for satellite input 2, after you have selected a programme preset for this input.

3. LNC 1

Option 1 Allows you to assign any of 3 frequency bands to dish antenna input 1. The bands are allocated as follows:

- a. ASTRA (10950 - 11700 MHz, Astra, Eutelsat, Intelsat)
- b. DBS (11700 - 12500 MHz, TDF, TVSAT, TELE-X, Olympus)
- c. T-COM (12425 - 12675 MHz, Telecom, Kopernikus)

Option 2 Allows you to assign any of 3 types of polariser in use to dish antenna input 1. These 3 types are:

- a. VOLT allows voltage switching to select the correct polarisation (H for Horizontal, V for Vertical). This is the default setting for dish input 1.
- b. MECH permits either Mechanical or Electro-Magnetic polariser capability.
- c. BEIDE allows dual band LNC switching (e.g. Astra / DBS) in addition to Mechanical or Electro-Magnetic polariser capability.

4. LNC 2

Allows you to assign any of the above mentioned 3 types of polariser in use to dish antenna input 2. Dish antenna input 2 does not have the frequency band selection. The satellite channel frequency indication will be:

- a. 10750 - 11700 (for Astra) if you select VOLT or MECH
- b. 10750 - 11700 (for low band, Astra) and 11700 - 12500 (for high band, DBS) if you have selected BAND.

5. H-POL BASE (Only for MECH or BAND dish input selection)

This option sets the polarity base setting for all the pretuned channels using the horizontal polarisation. Ensure you are on a channel with horizontal polarisation, then use the ◀ and ▶ keys to obtain a picture as free from sparkles as possible, then press the STORE key. Once correctly set, you should not enter this option any more.

6. V-POL BASE (Only for MECH or BAND dish input selection)

This option operates in a similar manner to the H-pol Base option described above. First choose a channel with vertical polarisation, then enter MENU 2 as before, and use the ◀ and ▶ keys.

Modifying Existing Programmes (Menu 1)

The Receiver is capable of storing 60 programmes and comes to you almost completely pre-tuned. If you wish to modify or add new programmes the following section explains the procedures.

- Select the programme you wish to modify
- Press MENU followed by 1.
- ▶ The ● light will be flashing and the menu shown will appear on your screen. If you decide not to modify anything or undo your modifications, press VIEW.

The MENU and ⏪ keys are used to move forward and backward through the menu, and the ◀ and ▶ are used to alter parameters. When you have finished your modifications, press STORE twice to enter your settings. The following 8 options are available, spread over 2 On Screen Menu pages:

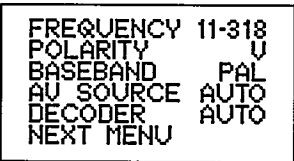

Note: once the MENU key has been pressed in the DECODER option, the second page will automatically appear.

1. FREQ

The satellite channel frequency can be adjusted and it is possible to directly enter the frequency using the numeric keys. For example, for a programme on the frequency of 11.214GHz, simply press the 1, 1, 2, 1, 4 keys.

Note : If LNC1 is selected the frequencies allowed will be dependant on the number stored in the LNC1 frequency option. (See section 'INSTALLATION MENU 'LNC 1)

2. POLARITY

The correct polarity must be assigned to each programme. This receiver can utilise Mechanical and Electro-Magnetic types of polarisers, but if you wish to use a voltage switching type of LNC, you must have selected VOLT on the polariser option. (See section 'Installation Menu'.)

Voltage Switching

LNC's that automatically select horizontal or vertical polarity depending upon the voltage supplied to the LNC, ensure a value of 18 volts for horizontal polarity and 14 volts for vertical polarity. These values are not adjustable and are indicated by the letter H or V on the screen.

The Electro-Magnetic Polariser

Horizontal and vertical, right hand circular and left hand circular settings are not indicated as such in this menu, but as a value in the range of 0-63.



The Mechanical Polariser

As with the Electro-Magnetic Polariser, the polarity settings of the Mechanical Polariser are indicated by a value in the range of 0-63.

Note: If the changes are made to the H-pol Base or V-pol Base in the LNC Offset menu, all 60 Channels will be reset to the new H-pol or V-pol Base setting. Press VIEW in case you decide not to make any alterations after you have already adapted some parameters.

3. BASEBAND

The baseband output is used to feed an external decoder. This signal falls into two main categories, PAL or MAC. This option allows you to switch the baseband output, provided by the DECODER/DESCRAMBLER socket, to be either filtered for a PAL decoder or flat for a MAC decoder.

4. AV SOURCE

The Audio and Video source can be selected from four options:

INT - internal audio and video. In this mode, any external decoder will be ignored.

AUTO - The default option for most programmes is AUTO so that, if a decoder providing the correct control signal is used, this decoder will be selected automatically when selecting this programme.

EXT V - Select this option if your decoder only treats the video of an encrypted programme.

EXT AV - Select this option if your decoder treats both audio and video of an encrypted programme. This option may have to be selected with some decoders that do not function if you have selected AUTO.

Note: If you select EXT V or EXT AV without a decoder fitted, the picture will disappear.

5. DECODER

This option is dependant on the setting of the AV source above.

If AV-source is AUTO, this question will be ignored.



If AV-source is INT, you can choose between NONE (normally the case) or INT. Only select INT if your receiver is equipped with an internal VideoCrypt decoder with Smart Card reader*.

If AV-source is EXT V or EXT AV, you can now select between EXT 1 or EXT 2. Only select EXT 2 if you have 2 decoders and the special connector lead connecting them to your Receiver. Consult your dealer for advice about this connector lead.

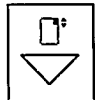

Note: For Receivers without an internal VideoCrypt decoder, the  key on the remote control has no function.





6. AUDIO

When in the Installation menu, the I-II key or  and  keys can be used to select the sound you want to hear. You may refer to the Satellite Programme Guide in the back of this manual to change or optimise your choice.

7. FREQ

Using the  and  keys, this option allows you to vary the audio frequency for both mono and stereo modes, thus enabling you to tune into programmes using audio frequencies different to the preset ones. MONO V will now show that it has been altered from its original setting (eg MONO 3). Use this option to obtain mono sound settings of 6.60 or 6.65MHz (see Satellite Programme Guide).

8. NAME

The default programme ident can be altered with this option. The  and  keys select alphas or numerics and pressing MENU will move the cursor to the next digit and so on. The  key will move the cursor back.

9. LNC

Your Receiver has 2 dish antenna inputs, thus allowing you to choose which satellite dish input you wish to use for each programme. If LNC 1 is selected, the satellite channel frequency range displayed in option 1 is dependant on the value assigned to the LNC1 frequency band in Menu 2.

Note: the number displayed does not affect the frequency input range.

AUDIO	STEREO A
FREQ	7-02 7-20
NAME	PR 1
LNC	1
BAND	HIGH
PANDA	ON

* INNOVATRON S.A. Licence

10. BAND

If BAND is selected in the polariser option in Menu 2, then this option will be available. It is intended for use with a dual band LNC.

If LOW is selected, the lower band of the dual band LNC will be activated (e.g. Astra). The voltage supplied to the LNC will be 14 V.

If HIGH is selected, the higher band of the dual band LNC will be activated (e.g. DBS). The voltage supplied to the LNC will be 18 V.

When all settings are as required, press the STORE key once to store your settings. This will bring the WHICH PROGRAMME prompt on screen. Select a programme number you wish to store this information against using the ◀ or ▶ keys or the numeric keys. Press the STORE key again. This will store all the settings for the programme and put the receiver back into normal mode. Programmes 59 and 60 have been designated TEST and AUX respectively and cannot be renamed; consequently the NAME option is not available on these programmes.

Adding New Programmes (frequency scan)

To add new programmes, it will be necessary to first locate them. This can be easily done using the frequency scan mode:

- Press MENU followed by 3.
- ▷ The ● light will start blinking.
- ▷ The receiver will scan for programmes on the polarity you were last viewing.

When the receiver finds a signal, the scanning speed will automatically decrease. This allows you the time to stop the scanning by pressing MENU. Automatically, Menu 1 will be displayed to alter other parameters if necessary, and to store the channel found under a new preset number. Continue as described in section "Modifying Existing Programmes (Menu 1)".

- Press VIEW to quickly end the scan.
- To scan for programmes on another polarity it is necessary to select a preset on this other polarity (see the Satellite Programme Guide). Then press MENU 3 again to re-start the scan.

Other Remote Controls

It is possible to operate your Receiver with a remote control other than the one delivered with the Receiver. Your Receiver is programmed to function as "Satellite 2". The remote control transmits signals in "Satellite 2" codes. Some multifunctional Philips remote controls have the "SAT" option. If they do not have the choice between "SAT1" and "SAT2", they will transmit SAT1 codes. Since your Satellite Receiver is functioning as SAT2, it will not react to those commands.

But you can change your Receiver from SAT2 to SAT1 and vice versa!

To Change from SAT2 to SAT1:

- Disconnect the Receiver from the mains.
- Reconnect the Receiver to the mains while holding the ⏻ and the - button on the front of the Receiver simultaneously for several seconds.

Now your Receiver will not react to the commands of its own remote control any more! Use a multifunctional Philips remote control and check if your Receiver reacts correctly. If this is not the case, follow the procedure below.

To Change from SAT1 to SAT2:

- Disconnect the Receiver from the mains.
- Reconnect the Receiver to the mains while holding the ⏻ and the + button on the front of the Receiver simultaneously for several seconds.

Your Receiver will now resume normal operation with its own remote control.



PICTURE

5

Reception of PAL and SECAM satellite signals with excellent quality
 Compatible with reception of MAC signals through MAC baseband decoder
 MAC signals passed on to TV via RGB for high quality pictures

OPERATION

60 Presets
 Fully Remote Controlled
 Remote controlled operation and installation using On-Screen Display
 48 Channels are factory pre-programmed
 4-Event VCR timer with Video Recording lock
 Sleptimer
 Parental lock per programme
 Receiver lock

RECEPTION

Frequency range	:950-1750MHz
Input level	:-62 to -25 dBm, 75Ω
IF Bandwidth	:27MHz
Demodulator	:PLL with threshold extension
Threshold	:C/N ≤6.5dB static
Frequency deviation	:16-25MHz/Vpp (PAL) :13.5 - 20MHz/Vpp (MAC)

VIDEO

PAL/SECAM	:4.8 MHz (-3dB)
-----------	-----------------

SOUND

Frequency response (DIN 45500)	:20Hz - 15KHz
Subcarriers	
Mono	:Tunable between 5.0 and 9.99 MHz
Stereo	:7.02 and 7.20 MHz :7.38 and 7.56MHz :7.74 and 7.92MHz :8.10 and 8.28MHz :Stereo channels can also be tuned
Noise Reduction System	:Panda 1

SATELLITE ANTENNA INTERFACE

Inputs	:2 IEC connectors
LNC supply	:14V, 18V (500mA) user selectable
Polariser control	:Pulse (mechanical, 0.8 to 2.2 ms) :Magnetic (ferrite, -80 to +80 mA) :"Marconi" type ("13/17V")

CONNECTIONS

TV	:Euroconnector for TV/monitor (RGB & CVBS)
VCR	:Euroconnector for VCR (CVBS)
Decoder/Descrambler	:Selectable de-emphasis (PAL/MAC) :Baseband output :Audio/Video input
Audio	:CINCH (L + R) 500mV constant level
UHF remodulator	:Tunable between channel 31-44 :Preset to channel 38 :With test picture generator :Terrestrial antenna input (IEC female) :Terrestrial antenna output (IEC male)
Satellite dish inputs	:Dish 1 (IEC female) :Dish 2 (IEC male)Polariser control :5 fold colour coded click-fits

SPECIFICATION

MISCELLANEOUS

Ambient temperature	:+5 to +45 °C
Mains	:220 to 240V ±10%, 50Hz
Power consumption	:≤ 35W :Standby ≤ 16W
Weight	:1.8Kg
Dimensions	:360 x 200 x 58mm

ACCESSORIES

Remote control	:RC5806
Coaxial antenna cable	:1.5 meter
IEC connector	:Male for dish input 1
Directions for use	:1 booklet

DECODER SCART

TV SCART

VCR SCART

1. Audio Out R (Decoder 1)	Audio Out R	Audio Out R
2. Audio In R (Decoder 1)	-	Audio In R
3. Audio Out L (Decoder 1)	Audio Out L	Audio Out L
4. Audio Earth (Decoder 1)	Audio Earth	Audio Earth
5. Blue Earth	Blue Earth	-
6. Audio In L (Decoder 1)	-	Audio in L
7. Blue In	Blue Out	-
8. Decoder 1 Status	CVBS Status	CVBS Status
9. Green Earth	Green Earth	-
10. Decoder 2 Baseband Out	-	-
11. Green In	Green Out	-
13. Red Earth	Red Earth	-
14. Decoder 2 Input	-	-
15. Red In	Red Out	-
16. RGB status	RGB Status	-
17. Decoder Earth	Video Earth	Video Earth
18. Decoder 2 Status	RGB Status Earth	-
19. Decoder 1 Baseband Out	Video Out	Video Out
20. Decoder 1 Input	-	Video In
21. Casing Socket Earth	Casing Socket Earth	Casing Socket Earth



6

FAULT

Receiver does not operate

If the Receiver does not give the desired result when used

Cannot select TV programmes when Receiver is switched on

With some TV sets it may be impossible to select a normal TV programme while the Satellite Receiver is switched on. This may be the case if, for example, you have your Satellite Receiver connected to your TV by means of an A/V connector cable and you want to make a recording of a satellite programme while watching a normal TV programme.

Poor reception

If you have followed carefully the instruction in section 2 HOW TO CONNECT YOUR RECEIVER, you should get clear pictures and sound

Scrolling picture on some programmes

The picture is not stable, scrolls or disappears and appears all the time.

Remote control does not work

If it seems the Receiver does not react to remote control commands.

CAUSE AND ACTION

- check the power and connection
- check the satellite dish antenna and/or A/V connections
- verify that the batteries of the remote control are not exhausted
- disconnect the receiver from the mains and reconnect it after waiting several seconds.

Note: You will have to set the internal clock again .

If this occurs, you should press the TV/SAT key on your remote control once. Now you can select and watch TV programmes.

If you wish to return to the satellite programmes, press the same TV/SAT key again.

If you have no problem changing TV channels while your Satellite Receiver is switched on, you do not need to use the TV/SAT key.

If not, check the section ' Modifying Existing Programmes (Menu 1)' carefully.

- adjust the satellite channel frequency in Menu 1 slightly using the ◀ and ▶ keys
- check the dish position

If this does not improve things, then the problem may be due to objects such as buildings or trees between your dish and the satellite. Ask your dealer for advice.

Try to optimise the reception following the procedure mentioned under **Poor Reception**. If this does not give the desired result, you may be tuned to a programme with conditional access for which you have no authorisation.

- verify that the ● light is not lit. If so, the Receiver is switched on to a timer event or is in sleep timer mode and does not react to remote control commands.

If you want to stop the sleeptimer, press ⏻.

If you want to cancel the timer event, press the

⏻ key quickly followed by VIEW. The timer event has now been cancelled and the Receiver will resume normal operation.

- verify that the batteries of the remote control are not exhausted.
- check that you did not accidentally reprogramme the Receiver to 'SAT1' (see 'Other Remote Controls' in chapter 4)

If you have any of the faults shown, take the required action and, if this does not achieve the required result

- consult your dealer

7

SATELLITE ASTRA 1-A 19.2° East

PR	Programme	Frequency	Pol	Transponder	System	Audio	Radio	Frequency
1	SKY 1	11.317	V	ASTRA 8	PAL	STEREO A	SKY RADIO	STEREO B
2	SKY NEWS	11.376	V	ASTRA 12	PAL	STEREO A		
3	SKY MOVIES PLUS	11.435	V	ASTRA 16	PAL (VC)	STEREO A		
4	EUROSPORT	11.258	V	ASTRA 4	PAL	MONO 2		
5	MTV	11.421	H	ASTRA 15	PAL	STEREO A	POWER FM	STEREO B
6	SCREENSPORT	11.214	H	ASTRA 1	PAL	MONO 3		
7	LIFESTYLE	11.273	H	ASTRA 5	PAL	MONO 2	ITN NEWS	
8	RTL 4	11.391	H	ASTRA 13	PAL *	STEREO A	RTL	STEREO B
9	FILMNET	11.362	H	ASTRA 11	PAL*	MONO 2	RADIO 10 GOLD	
10	TV3	11.244	H	ASTRA 3	D2MAC	STEREO A*		
11	SCAN SAT TV1000	11.303	H	ASTRA 7	D2MAC	STEREO A*		
12	TELECLUB	11.332	H	ASTRA 9	PAL*	MONO 2	OPUS RADIO	STEREO B
13	RTL PLUS	11.229	V	ASTRA 2	PAL	MONO 2	DEUTSCHE WELLE	STEREO B
14	SAT-1	11.288	V	ASTRA 6	PAL	MONO 2	DEUTSCHLANDFUNK NATIONAL EUROPE	STEREO B STEREO C
15	3 SAT	11.347	V	ASTRA 10	PAL	STEREO A		
16	PRO 7	11.406	V	ASTRA 14	PAL	MONO 2	STAR SAT ROPA	STEREO B STEREO C

SATELLITE ASTRA 1-B 19.2° East

17	PREMIERE	11.464	H	ASTRA 17	PAL*	MONO 2		
18	TELE 5	11.523	H	ASTRA 21	PAL	MONO 2		
19		11.582	H	ASTRA 25		MONO 2		
20	TV3 SWEDEN/NORWAY	11.641	H	ASTRA 29	D2MAC	MONO 2		
21	ARD 1 PLUS	11.494	H	ASTRA 19	PAL	MONO 2		
22	SES VIDEO	11.553	H	ASTRA 23	PAL	MONO 2		
23		11.612	H	ASTRA 27		MONO 2		
24	TV3 DENMARK	11.671	H	ASTRA 31	D2MAC	MONO 2		
25	SKY SPORT	11.508	V	ASTRA 20	PAL (VC)	MONO 2		
26		11.567	V	ASTRA 24		MONO 2		
27		11.626	V	ASTRA 28		MONO 2		
28		11.685	V	ASTRA 32		MONO 2		
29	THE MOVIE CHANNEL	11.479	V	ASTRA 18	PAL (VC)	MONO 2		
30		11.538	V	ASTRA 22		MONO 2		
31	SES INFO	11.597	V	ASTRA 26	PAL	MONO 2		
32		11.656	V	ASTRA 30		MONO 2		

* = Encoded

SKY MOVIES PLUS, SKY SPORT and THE MOVIE CHANNEL can only be viewed via a VideoCrypt decoder.

Note: All these allocations are subject to change.



SATALLITE EUTELSAT II F1 13.0° East

Pr	Programme	Frequency	Pol	Audio
33	SUPERCHANNEL	10.987	V	STEREO A
34	3 SAT	11.055	H	MONO V
35	SAT 1	11.095	H	MONO V
36	EUROSPORT		V	MONO 2

SATELLITE EUTELSAT I F5 10.0° East

37	RAI UNO	11.005	H	MONO V
38	TVE - INTERNATIONAL	11.149	H	MONO V

SATELLITE INTELSAT VA - F4 27.0° West

39	CHILDRENS CHANNEL	11.013	H	MONO V
40	CNN INTERNATIONAL	11.155	V	MONO V
41	DISCOVERY / KINDERNET	11.175	H	STEREO A

SATELLITE INTELSAT VA - F12 1.0° West

42	TV10 NORWAY	10.969	H	MONO V
43	TV4 NORWAY	11.683	H	STEREO A

SATELLITE TELECOM 1-C 5.0° West

44	CANAL PLUS	12.648	V	MONO V
45	LA CINQ	12.606	V	MONO V
46	M6	12.522	V	MONO V

SATELLITE TELE-X 5.0° East

47	TV4	12.207	V	STEREO A
----	-----	--------	---	----------

SATELLITE OLYMPUS 18.8° West

48	RAI SAT	12.168	V	MONO 2
----	---------	--------	---	--------

Note: All these allocations are subject to change.



GB IDENTITY CARD

This card together with the terms of guarantee (to be provided by your dealer) forms the full certificate of guarantee for this appliance.

D GERÄTE-
KENNKARTE

Diese Karte ist, zusammen mit den Garantiebestimmungen, die Ihr Händler Ihnen aushändigt, Ihr Garantieschein für dieses Gerät.

F CARTE
D'IDENTIFICATION

Associée aux conditions de garantie (qui vous sont remises par le revendeur), cette carte constitue le certificat de garantie de cet appareil.

I CARTE
D'IDENTIFICAZIONE

Questa cartolina rappresenta insieme alle condizioni di garanzia (da consegnare dal vostro rivenditore) il documento di garanzia per questo apparecchio.

HU

Ez a lap a jótállás feltételeivel együtt (az Eladó Kereskedője adja) képezi teljes egészében ennek a készüléknek Garancia Igazolványát.

PHILIPS

